

7-1-2016

Differential Association of Vitronectin and Fibronectin with Glass and Electrospun Fibers of a Poly (D-Lysine) /Poly (Acrylic Acid)

Syed Muhammad Sohaib Zafar Zafar
University of South Florida, sohaibzafar110@gmail.com

Follow this and additional works at: <http://scholarcommons.usf.edu/etd>

 Part of the [Biomedical Engineering and Bioengineering Commons](#), and the [Biophysics Commons](#)

Scholar Commons Citation

Zafar, Syed Muhammad Sohaib Zafar, "Differential Association of Vitronectin and Fibronectin with Glass and Electrospun Fibers of a Poly (D-Lysine) /Poly (Acrylic Acid)" (2016). *Graduate Theses and Dissertations*.
<http://scholarcommons.usf.edu/etd/6444>

This Thesis is brought to you for free and open access by the Graduate School at Scholar Commons. It has been accepted for inclusion in Graduate Theses and Dissertations by an authorized administrator of Scholar Commons. For more information, please contact scholarcommons@usf.edu.

Differential Association of Vitronectin and Fibronectin with Glass and Electrospun Fibers of a
Poly (D-Lysine) /Poly (Acrylic Acid)

by

Syed Muhammad Sohaib Zafar

A thesis submitted in partial fulfillment
of the requirements for the degree of
Master of Science in Materials Science and Engineering
Department of Chemical and Biomedical Engineering
College of Engineering
University of South Florida

Co-Major Professor: Donald Haynie, Ph.D.
Co-Major Professor: Nathan Gallant, Ph.D.
Piyush Koria, Ph.D.

Date of Approval:
June 27, 2016

Keywords: Serum Proteins, Integrins, Focal Adhesions

Copyright © 2016, Syed Muhammad Sohaib Zafar

DEDICATION

I dedicate this thesis to my family whose prayers, strength, guidance and support has made me who I am today and who I will become. I could not have done it without you.

ACKNOWLEDGMENTS

I would also like to offer special thanks to my advisor Donald T Haynie for his guidance. You have been a great motivation which has seen me through I am honored to have been blessed with such a teacher as you. I would like to thank Dr. Nathan Gallant and Dr. Piyush Koria for serving on my thesis committee and providing me with valuable feedback, I would also like to thank Mr. John Schreiber a senior Ph.D. student in the Physics Department of the University of South Florida for his advice throughout my research.

TABLE OF CONTENTS

| | |
|--|-----|
| LIST OF TABLES | ii |
| LIST OF FIGURES | iii |
| ABSTRACT | iv |
| CHAPTER 1: INTRODUCTION | 1 |
| 1.1 Goal and Objective | 1 |
| 1.2 Biopolymers | 3 |
| 1.3 Integrin-Mediated Cell-Adhesion | 5 |
| 1.4 Protein Adsorption | 7 |
| 1.5 Vitronectin | 8 |
| 1.6 Fibronectin | 12 |
| 1.7 Electrospinning Peptides | 15 |
| CHAPTER 2: ELECTROSPINNING OF SYNTHETIC POLYPEPTIDE FROM AQUEOUS SOLUTION..... | 18 |
| 2.1 Introduction..... | 18 |
| 2.2 Materials | 20 |
| 2.2.1 Electrospinning | 20 |
| 2.2.2 Crosslinking | 21 |
| 2.2.3 Cell Culture..... | 21 |
| CHAPTER 3: CHARACTERIZATION OF NANOFIBERS..... | 22 |
| 3.1 Imaging | 22 |
| 3.2 Immunofluorescence..... | 25 |
| 3.2.1 Antibodies | 26 |
| 3.2.2 Surface Coating | 26 |
| 3.2.3 Quantum Dots | 28 |
| CHAPTER 4: DISCUSSION AND CONCLUSION | 29 |
| 4.1 Results | 29 |
| REFERENCES | 35 |
| APPENDIX A: COPYRIGHT PERMISSIONS | 38 |

LIST OF TABLES

| | | |
|---------|--|----|
| Table 1 | Commonly used biopolymers | 5 |
| Table 2 | Proteins, peptides and blended polymers reportedly used in electrospinning | 17 |
| Table 3 | Immunoassay specimen trials | 27 |

LIST OF FIGURES

| | | |
|-----------|--|----|
| Figure 1 | Surface modification techniques | 7 |
| Figure 2 | Localization of vitronectin domains as illustrated above (A) | 11 |
| Figure 3 | Modular structure of fibronectin | 14 |
| Figure 4 | Poly (acrylic acid) crosslinked with poly-(D-Lysine) | 24 |
| Figure 5 | PAA/PDL fibers cultured with fibroblast | 24 |
| Figure 6a | VTN 5%- FN 1% | 30 |
| Figure 6b | VTN 10%- FN 2 % | 31 |
| Figure 6c | VTN 15%-FN 3 % | 32 |
| Figure 6d | VTN 20%-FN 5% | 33 |
| Figure 6e | 10% FBS | 33 |
| Figure 6f | 10% FBS | 34 |
| Figure 6g | 10% FBS | 34 |

ABSTRACT

Proteins represent major constituent of the extracellular matrix which plays an important role in the formation, maintenance and remodeling of tissues, this project focuses on adsorption of two specific serum proteins fibronectin (FN) and vitronectin (VTN) responsible for mediating cell matrix interaction through integrin binding, tripeptide Arg-Gly-Asp (RGD) sequence found in these protein features are recognized by $\alpha\beta V_3$ integrin which ultimately helps in clot formation.

CHAPTER 1: INTRODUCTION

1.1 Goal and Objective

The goal of this research is to determine adsorption of two specific serum proteins FN and VTN on glass and fibers made of a polymer blend of poly (D-Lysine) and poly (acrylic acid). This project has been motivated by an earlier study on co-poly-(L-Glu₄, L-Tyr₁) PLEY (20-50 kDa) in Haynie's Lab materials made from these fibers are potentially useful as in vitro cell culture scaffolds and implantable materials.

We hypothesized that protein adsorption can mediate cellular interaction with glass and nanofibers through focal adhesions. Protein and peptides are the building blocks of cell and tissue and play a vital role in cell signaling, differentiation, plus the relative ease of availability and possibility to synthesize different peptides of variable chain length.

Poly (D-Lysine) /PAA mats will be fabricated using electrospinning followed by crosslinking with 50 Mm EDC diimide crosslinker, initial visualization will be achieved by coating FITC-PLL which will aid in studying VTN and FN adsorption on fibers versus glass.

Lysine is a designed peptide consisting of synthetic homopolymer resembling glutamic acid, all chiral amino acids in proteins other than glycerin, are levorotatory, it consists of L-amino acid only, aromatic side chains play an important role in nucleating protein folding and forming hydrophobic core of the native state of globular protein.

No other peptide has side chains with aromatic rings with exception poly (γ -benzyl-L-glutamate), to date only a few polypeptides of any sequence have been provided spinnable under conditions let alone water.

I am interested in studying focal adhesions that mediate signals modulating cell attachment, migration, proliferation, differentiation, and gene expression. α - β integrin heterodimer transmembrane core of FN and VTN forms focal adhesions which bind the extracellular matrix on its extracellular region, constitutes the site of anchorage of the actin cytoskeletons to the cytoplasmic side of the membrane and mediates intracellular signaling pathways (Burridge et al., 1988; Hynes, 2002; Jockusch et al., 1995; Schwartz et al., 1995).

I will be using different tools for these purposes such as Zeiss inverted microscope to study auto-fluorescence using DAPI filter set (excitation at 385nm, emission at 461 nm) and laser scanning confocal fluorescence microscopy at the medical school using FITC filter set (excitation at 495nm, emission at 525 nm) and image processing tool such as image J, Confocal microscope will also be used to study pixel size in horizontal and vertical dimensions at different magnifications.

Before preparing the polymer feedstock peptide concentration will be calculated based on the Beer-Lambert law, using UV Jasco V660 spectrophotometer, both glass and indium tin oxide coated poly (ethylene terephthalate) ITO-PET will be used as substrate materials, poly (D-Lysine) mats will be visualized by bright field and fluorescence microscope and documented by photography before and after cross-linking.

Peptide based nanofibrous mats will be cross-linked by submerging samples in 20mL of 50mM EDC in 90% ethanol at ambient temperature for six hours, the conjugate dye will be labeled by immersing EDC cross-linked PDL fibers in 2mg/mL concentrated fluorescein isothiocyanate which will further be visualized by laser scanning confocal microscope.

1.2 Biopolymers

A majority of the living organism, including humans constitutes polymers in a variety of shape, size and structure such as; proteins, carbohydrates, and nucleic acid. Biopolymers are either derived or synthesized from biological sources which are inherently “biocompatible” and “biodegradable”, due to these potential advantages synthetic polymers have piqued a lot of attention lately to cope with different subcutaneous and anatomical conditions.

Some commonly used benign polymers that have been FDA approved for clinical application include; polymethyl-methacrylate (PMMA) widely used in lenses, synthetic poly (α -hydroxyesters) such as polyglycolic acid (PGA), and their copolymers poly (lactic-co-glycolic acid) (PLGA) and poly- ϵ -caprolactone (PCL) are hydrophobic in nature reportedly used as implant specially for resorbable bone fixtures and suture materials. Polymers can be tailored to mimic proteins which are often inexpensive alternative, peptides are excellent examples of synthetic polymers that can translate biological information in response to environmental stimuli opening opportunities in drug delivery, orthopedics, tissue engineering and variety of other implant related applications.

Researchers are working on peptides that can hierarchically self-assemble into ordered conformations to create vesicular nanostructures, whereas secondary and tertiary structures can also be achieved by incorporating functional groups.

Designed polypeptides can be triggered by any physiological or biological stimulus in human body, such as pH, temperature, and enzymes, which makes it ideal for control release therapeutics that can undergo size change and solubility promote phase transitions such as gelatin, detach functional moieties and cause conformational changes.

Although a wide variety of synthetic polymers are available in the market, but growing demand has also raised questions regarding the health concerns of products such as toxicity through residual monomers or chronic inflammatory reactions.

Natural polymers are viable alternatives and promising candidates derived from extracellular matrix (ECM) consisting of biological cues and physio-chemical features for cellular signaling.

Collagen is a naturally occurring matrix polymer found in connective tissues such as; ligament, cartilage, bone and skin, although 19 different types of collagen are available only type I, II and III have been reportedly used for clinical application as scaffolds, sponges, meshes or hydrogel.

Fibrin is another example of natural polymer with biometric features widely used as a tissue adhesive scaffold for surgical wound repair mediating blood coagulation. Due to their biological origin natural polymers are inherently non-toxic with controlled degradation rates ranging from days to weeks through enzymatic activity, biopolymers aims to mimic the certain aspects of ECM thus regulating cell adhesion, migration and proliferation [10, 11, 12].

Table 1: Commonly used biopolymers. [4]

| Polymer | Monomers | Functions |
|-----------------------|-----------------------|---|
| Nucleic Acid | Nucleotides | Carriers of genetic information, universally recognized in all organisms. |
| Proteins | α -amino acids | Biological catalysis (enzymes), growth factors, receptors, structural materials, (insulin); toxins; antibodies. |
| Polysaccharides | Sugars | Structural materials in plants and some higher organisms (cellulose and chitin); energy storage materials (starch and glycogen); molecular recognition (blood types); bacterial secretions. |
| Polyhydroxylalkanates | Fatty acids | Microbial energy reserve materials. |
| Polyphenols | Phenols | Structural materials in plants (lignin), peat and humus; plant defense, mechanisms (tannins). |
| Polyphosphates | Phosphates | Inorganic energy storage materials |
| Polysulfates | Sulfates | Inorganic energy storage materials |

1.3 Integrin-Mediated Cell-Adhesion

Cells constitute a major part of all living organisms found in nature, such as tissues and organs surrounded by a network of complex structural proteins and proteoglycans called the extracellular matrix (ECM) providing structure and biological cues for homeostasis, morphogenesis, and differentiation.

ECM constitute two major macromolecules proteoglycans and fibrous proteins (which include collagen, elastin, fibronectin, and laminin) crucial in adhesion and activating intracellular signaling pathways through cell surface adhesion receptors known as integrin which ultimately cluster to form focal adhesions.

Integrins are α and β heterodimers which determine extracellular binding specificity mediating actin cytoskeleton-ECM interaction, multiple ligands can bind to specific integrin receptor for example; α V β 3 interact with VTN, FN, von willenbrand factor, thrombospondin, osteopontin.

Adhesion proteins play an important role in binding cells to fibrous collagen and other matrix component generally cells do not bind directly to matrix proteoglycans or type IV collagen rather laminin anchors cell surface to basal lamina, such as epithelial and fat cells (Molecular Cell Biology, Darnell, et al., 1990).FN promotes cell adhesion to the substratum and regulate the shape and organization of cytoskeleton essential for many types of cell migration and cellular differentiation processes.

Another important function involves wound healing process, by facilitating macrophages and other immune cells to migrate into the affected area and initiation of blood clot by allowing platelets to adhere to damaged regions. (Molecular Cell Biology, Darnell, et al., 1990).

Cell-matrix adhesion mechanisms determine overall tissue architecture, provides critical biological communication for cellular function such as; migration and activating signal transduction pathways that induce growth, proliferation and gene expression. It has also been found to regulating pathological conditions such as; clotting, inflammatory deficits as well as cancer invasion and metastasis and abnormal adhesive interactions (Bunting et al., 2002; McEver, 2001; Brakebush et al., 2002).

1.4 Protein Adsorption

In order to achieve desired biological responses, biocompatibility and surface interface interaction are crucial since body recognizes biomaterials as foreign object, protein adsorption and adhesion are crucial to cell surface receptors (integrins). A very rapid process that takes place within seconds ultimately paving pathways to mediate cellular interactions.

Diffusion occurs in order of molecular weight, smaller proteins such as thrombin, 35 kDa attaches first followed by IgG at 160kDa. Rate of absorption can be affected by conformational changes, size and shape of the molecule, ligand binding characteristics and amino acid sequence.

Surface features and properties such as topography, morphology, hydrophobicity also contributes towards diffusion rates to improvise proper diffusion ideal surfaces should be rough (proteins do not adhere to smooth surfaces) with no steric hindrances out of a wide variety of modification techniques available three main categories are reported; physical, chemical, and biological.

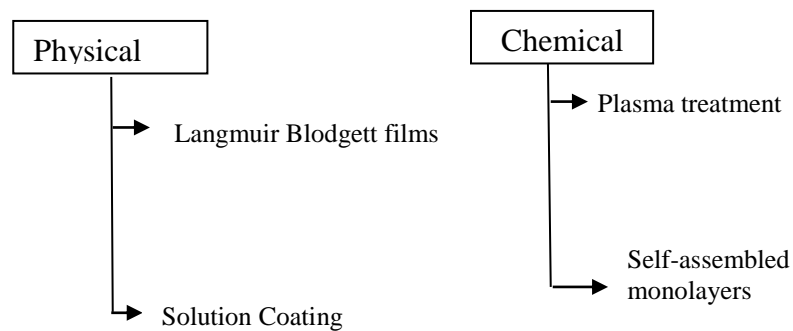

Figure 1. Surface modification techniques

These advanced treatments can be used for metals, polymers and ceramics significantly modifying protein adsorption such as the case with plasma treatment which makes surfaces more hydrophilic, especially important in the case of hemocompatible devices such as heart valves and vascular grafts, similarly self-assembled monolayers (SAMs) technique modify surface adsorption by creating molecularly smooth surfaces for attaching bioactive molecules.

Langmuir-Blodgett films are physical modification meaning they are non-covalent and analogous to SAMs, these techniques are used to create molecularly smooth surfaces that are amphiphilic, and this involves pushing amphiphilic molecules in an orderly manner and forcing them to adhere biomaterial.

Solution coating is another type of physical modification that is used to enhance bioactivity and alter hydrophobicity, due to the versatile nature of this technique it can be applied to all types of biomaterials.

The process involves dipping the specimen into a polymer solution dissolved in an organic solvent followed by drying in order to allow polymer coating to deposit material.

Adsorption is complicated process involving a number of factors such as; surface-protein interactions, van der waals, hydrophobic and electrostatic interaction and hydrogen bonding [34].

1.5 Vitronectin

A major cell attachment protein found in plasma and extracellular matrix know as a ‘serum adhesion factor’ providing unique regulatory link between cell adhesion and proteolysis.

VTN is found in human blood in two molecular forms, plasma concentration in human ranges 200-400 $\mu\text{g/ml}$ with an average molecular weight 75kDa regulating immune responses and clot formation.

Cell adhesion and migrations are mediated through Arg-Gly-Asp (RGD) sequence residues (45-47) present in its NH₂ terminus which (figure 2A) binds specific cell surface receptors (integrins) $\alpha_v\beta_5$, $\alpha_v\beta_1$, $\alpha_{IIb}\beta_3$, $\alpha_v\beta_6$ and $\alpha_v\beta_8$ to the extracellular matrix.

$\alpha_v\beta_3$ expressed by endothelial cells play an important role in angiogenesis, whereas $\alpha_v\beta_5$ and $\alpha_8\beta_1$ have been considered as surface receptors non-covalently bound to α - β heterodimer that spreads through the plasma membrane upon binding these integrins initiate signaling pathways regulate cytoskeletal reorganization, intracellular ion transport, lipid metabolism and gene expression.

Protein phosphorylation is the earliest event detected in response to these stimulations that transmit signals throughout cells promoting adhesion and spreading through threonine⁵⁰ and threonine⁵⁷ residues adjacent to the RGD domain (figure 2 B).

Cyclic AMP dependent protein kinase (PKA) sequence and protein kinase C (PKC) phosphorylate VTN at Ser³⁷⁸ and Ser³⁶² (figure 2B) activate plasminogen these kinase are released from thrombin-stimulated platelets and in blood cells as ectoenzymes modulating conformation.

VTN has shown involvement in the formation and dissolution of blood clots, the susceptibility of thrombin, elastase and plasmin found in wound healing area reduces plasminogen activator inhibitor binding, which transmits it from an antifibrinolytic protein to profibrinolytic protein dissociating PAI-1 and converting it into a noninhibitory protein.

A number of biological functions are governed by ligand binding which attaches preferentially to VTN these include; collagen, glycosaminoglycan's, β -endorphin, type-1 plasminogen activator inhibitor and urokinase receptors.

Collagen is bound through heparin and RGD domain, amino terminal (1-44) (figure 2A) and the carboxyl end (residues 332-348) (figure 2B) of VTN bind plasminogen activator inhibitor-1.

Carboxylic edge consist of sequence responsible for binding glycosaminoglycan (GAG) which helps in anchoring extracellular matrix, whereas urokinase function as an extra set of receptor that localizes VTN to focal adhesions, mediating proteolysis by activating plasminogen activator inhibitor-1 henceforth reducing tumor progression and metastasis cancer.

Physiological processes such as coagulation and fibrinolysis, cell migration and cytolytic reaction of terminal complexes have been linked with thrombin-antithrombin III complexes, heparin and complement binding.

COOH terminus consists of highly basic heparin binding domain VTN neutralizes its activity protecting thrombin from rapid heparin dependent inactivation by antithrombin III rendering coagulation enzymes from inhibition. [7, 8, 17, 18, 23].

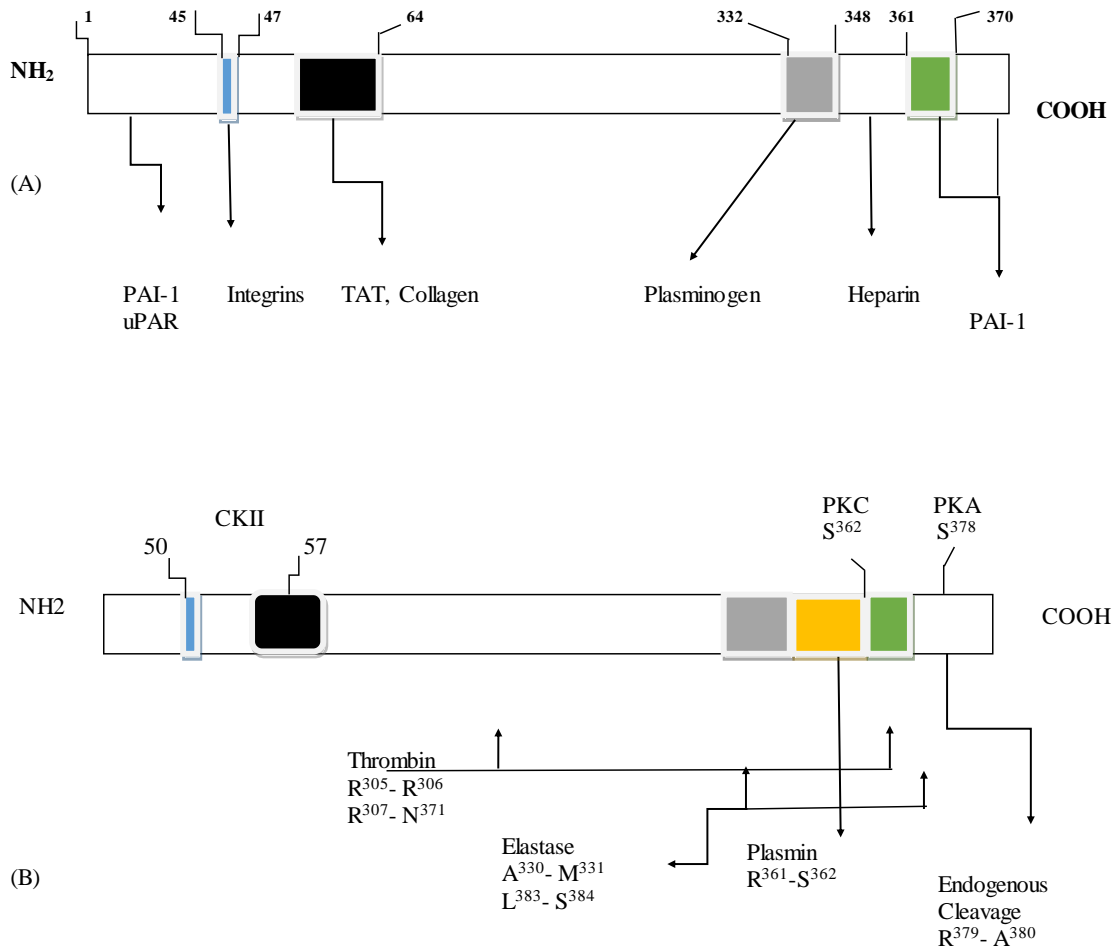

Figure 2. Localization of vitronectin domains as illustrated above (A). The lower panel shows the localization of proteolytic cleavage sites (B) adapted from [8]

1.6 Fibronectin

Discovered in late 1973 and 1978, as an adhesive glycoprotein in plasma and cell surface named after its fibrous structure and glue like properties with an average molecular mass 450,000 dalton and plasma concentration 300 μ g/ml lately, this glycoprotein has gained much attention researchers are trying to find binding domains due to its active role in viral infections.

Fibronectin (FN) mediate matrix interaction through its homologous functional domains which links surface receptors and integrins, unlike fibrin or basement membrane that self-polymerize in physiological solution.

FN extends its carboxylic ends and folds inwards attaining a globular shape whereas forming multimeric fibrous strands covalently joined at the amino terminal transforming from globular dimer protein to insoluble.

More or less 90% of the amino acid sequence is made up of three types of homologous units, type I consist of 12 modules, 2 type II modules, 15 to 17 type III modules and a variable (V) sequence (figure 3).

FN binds specific surface receptors regulating signaling pathways and cellular functions such as differentiation, proliferation, and migration, several integrins bind FN such as the classic $\alpha_5\beta_1$ and $\alpha_{IIb}\beta_3$ through a tripeptide cell adhesion (RGD) motif located in III10 regions.

Pro-His-Ser-Arg-Asn sequence creates a distinct binding site for $\alpha 5\beta 1$ due to loop formed in III10 and synergy region from III9 (figure 3), promoting integrin mediated cell adhesion and intracellular signaling pathways.

C-terminal part and N-terminal end consist of two heparin domains that interact with heparin sulfate proteoglycans; high-affinity domain interact with glycosaminoglycan and chondroitin sulfate whereas low-affinity domain bind FN to bacteria, collagen bind I₆₋₉ and II_{1, 2} domains (figure 3) both native and denatured (gelatin) collagen bind FN.

N-terminal bind fibrin through two major sites (fibrin I and fibrin II) constituting type 1 repeats 4 and 5, FN has known to mediate cell adhesion and migration when crosslinked into fibrin clots by factor XIII transglutaminase, it also clears up macrophages from circulation after trauma or inflammation.

In conclusion, FN role as a multi-domain protein regulating cell-mediated processes through specific integrin ligand binding makes it an ideal candid for a diverse range of biological functions such as cell attachment, clot stabilization, wound healing, and platelet attachment.

FN participate in the healing process by forming a scaffold upon which extracellular matrix components like collagen, heparin sulfate, proteoglycan, and chondroitin are deposited, it has been found to be an important tool in nerve regeneration and embryogenesis by enhancing lymphocyte binding to macrophages [13, 14, 15, 16, 25].

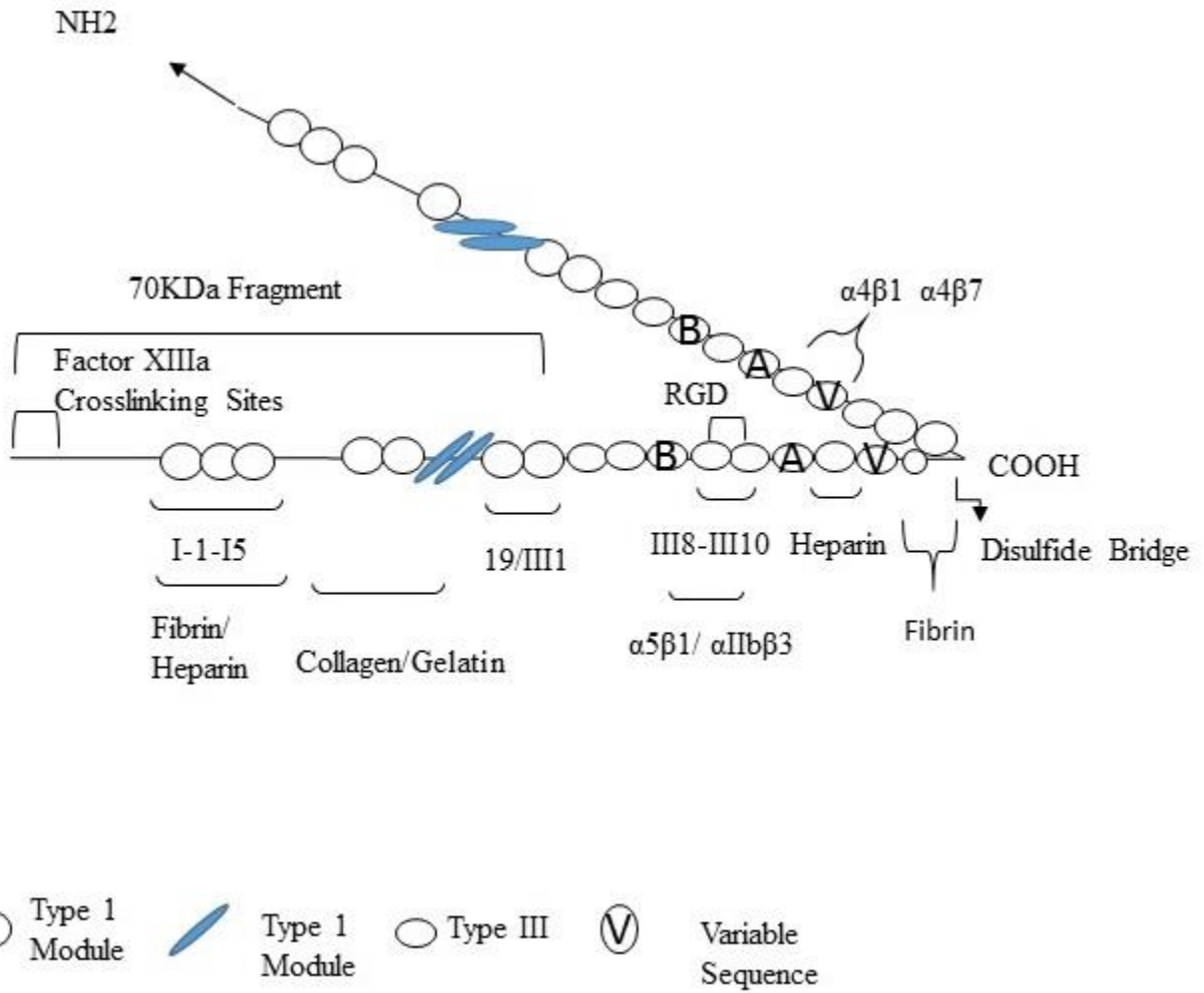

Figure 3. Modular structure of fibronectin [13]

1.7 Electrospinning Peptides

Over the past decades demand for biomaterials have increased exponentially with limited organ transplantation, advancement in medical technology has become an increasingly important extensive research has been going on to recreate extracellular microenvironment with morphological and physiological features resembling native tissue to foster cell-material interactions.

Synthetically designed stimuli-responsive peptides hold considerable potential for biomedical application due to their structural and functionally versatile nature and protein mimicking abilities, peptides are benign polymers that are either derived from natural sources or engineered to hierarchically self-assembled as a result of pathological conditions which makes it suitable for a variety of tissue engineering and drug delivery applications.

Electrospinning is a simple yet versatile technique used to create nanofibrous mats that has been extensively researched due to its high surface area to volume ratio and morphological resemblance with extracellular matrix.

To date electrospinning has been applied for variety of biodegradable polymers such as; poly (ϵ -caprolactone) (PCL), poly (lactic acid) (PLA), poly (glycolic acid) and the copolymer poly (lactide-co-glycolide) (PLGA) also some key structural proteins such as collagen and elastin have been utilized.

Huang and coworkers were first to electrospun collagen mats for wound dressing followed by mathew et.al and boland et al. electrospinning collagen and elastin fibers for preliminary vascular tissue engineering [28].

Among different stimuli-responsive peptides poly (L-lysine) (PLL) and poly (L-glutamic acid) (PLGA) has been extensively researched, organic polymers with protein blends have also been incorporated in the electrospinning to improve mechanical properties and functionality of the fibrous mats. Some examples include; poly (dioxanone), poly (ethylene oxide), poly (ethylene terephthalate), poly (D, L-lactide-co- ϵ -caprolactone), poly (styrene) and poly (vinyl alcohol).

Synthetic peptides exhibit several attractive features compared to alternative polymers such as minimum risk of pathogens or contamination flexibility of attaching biologically active motifs that promote cell attachment, exceptional physiological compatibility, and minimum toxicity, in short peptides holds great potential for matrix culture transplantation [6,10,7,12,28].

Table 2: Proteins, peptides and blended polymers reportedly used in electrospinning

| Polymers | Applications | Ref |
|--------------------|--|-----|
| Collagen | Tissue engineering, drug delivery, vascular tissues, wound healing. | 6 |
| Elastin | Biomedicine, wound healing, tissue engineering, drug delivery | 6 |
| Fibrinogen | Vascular tissue engineering, 3d scaffolds promoting cell adhesions to matrices. | 6 |
| Gelatin | Induce morphogenesis, promote adhesion, tissue engineering biomedicine | 6 |
| Poly-L-lactic acid | Drug delivery, control release and presentation of growth | 12 |
| Poly glutamic acid | Self-assembly, control drug release, 3d scaffolds | 10 |
| Poly-L-lysine | Polymer scaffolds for wound healing application with possibility of targeted drug release profiles | 7 |

CHAPTER 2:

ELECTROSPINNING OF SYNTHETIC POLYPEPTIDE FROM AQUEOUS SOLUTION

2.1 Introduction

There has been an ever growing demand for biocompatible materials that can mimic or recreate extracellular microenvironment with tailored geometry, spatial distribution and porosity that allow cells to diffuse through macroporous structures.

Electrospinning is a versatile technique that allows us to fabricate mats with high surface area to volume ratio that can facilitate interaction between host cell and material.

High void volume found in nanofibrous architecture are ideal for cell migration, proliferation and vascularization whereas surface morphology such as; porosity and roughness helps to improve mechanical interlocking at tissue-implant interface as well as protein adsorption by providing necessary physical cues [1,2,5,6,9,10,11,12,20,21]. Biopolymers from natural, artificial and blended sources have been spun for variety of biomedical applications such as drug delivery, tissue engineering and antibodies [28].

Some of the most commonly reported biodegradable polymers include; poly (ϵ -caprolactone) (PCL), poly (L-lactic acid) (PLA), poly (glycolic acid) (PGA) and copolymer poly (lactide-co-glycolide) (PLGA). Peptide based materials derived from natural or synthetic building blocks have gained a lot of attention lately due to their protein-mimicking properties, amino acid side chains in these biomacromolecules consist of stimuli responsive functional groups that can tailor structure as a result of supramolecular interactions.

Designed peptides can be triggered to different pathological changes observed in human body such as: pH, redox potential, temperature, light and enzymatic reactions resulting in hierarchical self-assembly due to controlled conformational changes in the secondary (α -helix or β -sheet) and tertiary structures. Thus aiding peptide based biomaterials in a variety of control release biomedical application.

Engineered peptides offers improved therapeutic efficacy and control over the target disease by incorporating functional moieties that are cell-specific and can be triggered to environmental stimuli, less immunogenic degrading into shorter chain amino acid decreasing chances of toxicity.

The ability to control therapeutic behavior of biomaterials that undergo physiochemical changes due to environmental trigger have piqued a lot of attention in developing peptide-based delivery systems, there are drastic changes in human physiology from the gastrointestinal tract (pH-1.3) to the stomach (pH 5-8).

Poly-L-lysine (PLL) is one such polymer that responds to changes in pH by transforming from α -helix to extended random coil like structure with pKa value 10.53.

In a recent study, researchers tried blending lysine in poly-L-glutamic acid (PLGA) to create water permeation membrane utilizing helix-coil conformational transition as a function of switches in pH, whereas they envisioned drug carrier that respond to different pH when incorporated in reversible vesicles composed of PLL α -helix rods sandwiched between PLGA segments, lysine based hybrid copolymers holds much promise in nano-biotechnology.

The work presented here describes electrospinning poly (acrylic-acid) (PAA) mats with different concentrations of lysine from aqueous solution, which were later cultured and stained in an attempt to quantify serum protein adhesion to glass and electrospun fibers.

Poly-D-lysine. HBr (PDL) is a cationic polymer that forms an amide linkage with acidic polyelectrolyte (PAA) through covalent interaction between the amine and carboxylic side chains.

2.2 Materials

Poly-D-Lysine. HBr (PDL) 1000-5000Da from Sigma-Aldrich (USA), poly (acrylic acid) with an average molecular mass 300,000Da was purchased from Polysciences Inc and deionized water.

2.2.1 Electrospinning

Electrospinning was carried out according to the procedure detailed by Khadka et al. Polymer solution was loaded into a 1mL plastic syringe Fisher (USA) equipped with blunt tip 0.6mm diameter needles from Jenson Global (USA) placed on syringe pump.

The Positive potential of 6-7kV was applied to the needle relative to the ground through PS/20P15.0-11 Glassman High- Voltage Inc. (USA) power supply. Electrospun fibers were collected onto 18x 18mm² glass coverslips (Fisher USA) grounded with alligator clips, polymer feedstock rate was kept 0.210 μ L/min with an air gap distance of 12cm determined after trial and error until fibers started spinning.

The concentration of PAA-PLL were 25% and 6% (w/v) respectively, to get maximum cross-link of the available sample D-Lysine was incorporated based on residue-mole ratio we started with 10:1 ratio and from their different concentrations 6, 3, 1, and 0.5% (w/v) ratio was studied we it was found that 6% (w/v) % works best.

2.2.2 Crosslinking

1-ethyl-3-(3 dimethylaminopropyl) carbodiimide (EDC; Thermo Scientific, USA) in 90% ethanol was used to stabilize amide linkage between D-Lysine and carboxylic acid.

Samples were submerged in 20mL of 50mM EDC at ambient temperature covered with paraffin for overnight followed by rinsing them in water bath to remove excessive crosslinker and then dried to check viability samples were once again rinsed in water and ethanol.

2.2.3 Cell Culture

Normal human dermal fibroblast (Lonza USA) was used for initial assessment of attachment and proliferation on electrospun fibers.

Lyophilized media kept at -80 C was preheated for 30 minutes in a water bath, 1mL of media was covered onto 65mm x 10mm sterilized petri dish (Santa Cruz) each petri dish was labeled and examined under microscope to ensure cells are alive.

CHAPTER 3:

CHARACTERIZATION OF NANOFIBERS

3.1 Imaging

Cell-cultured samples were visualized on a dissecting microscope and inverted microscope (Zeiss Axiovert 200 M, Germany) to get more detailed images of areas with high fiber to cell density.

Next, fluorescence imaging was utilized to study growth and proliferation, cells were fixed after six days of initial seeding followed by drying off media and placing them in 4% (w/v) paraformaldehyde at ambient temperature for 20 minutes the solution was then dried off and rinsed with 1X PBS twice.

Cells were permeabilized with triton X100 (Promega USA) bath and left to incubate for 20 minutes at ambient temperature, followed by drying and rinsing with 1X PBS, to reduce background staining cell were further incubated for 30 minutes in 1% serum and rinsed off twice in PBS.

In the next step electrospun samples were visualized using fluorescein isothiocyanate-conjugated poly (L-lysine) FITC-PLL (Sigma USA) associated with an anionic portion of PAA, whereas cell nuclei was tagged with 4-6-diamidino-2-phenylindole DAPI (Invitrogen USA) finally actin filament were visualized with rhodamine-conjugated phalloidin (Invitrogen USA).

Samples were afterwards placed onto quartz microscope slide coated with prolonged gold antifade to prevent loss of fluoro activity, and kept in dark inside biosafety cabinet for overnight.

Cells were then visualized using Rho, DAPI, and FITC filters in combination with X10, X20, X40 magnification. To get composite images we used image J, pseudo-coloring actin filaments red, cell nuclei blue and crosslinked fibers green.

Preliminary results of electrospun samples were promising but were embedded with flaws such as uniformity, fibers appeared splotchy and unorganized floating frequently in the media throughout the staining process, on contrary actin filaments showed preference to fibrous matrices and cells started multiplying rapidly. It was evident that cells were showing preference to electrospun fibers, but due to lack of control group it was not possible to quantify how many cell adhered to glass compared to fibers.

In order to validate results working parameters were improvised to attain uniformity in electrospun mats by adjusting flow rates in the spinning process and spinneret to collector distances, similar background staining was rectified by adding positive and negative controls.

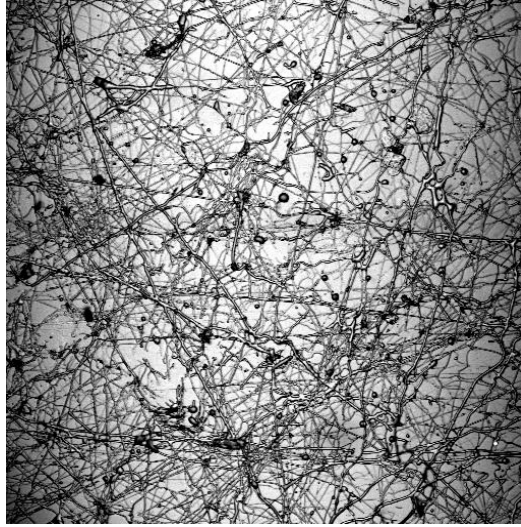

Figure 4. Poly (acrylic acid) crosslinked with poly-(D-Lysine)

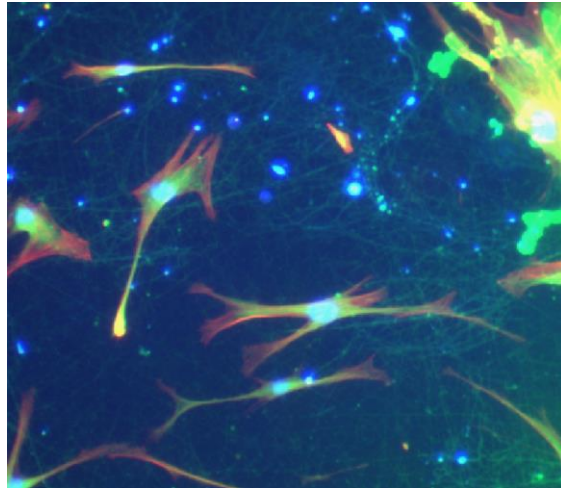

Figure 5. PAA/PDL fibers cultured with fibroblast

3.2 Immunofluorescence

A biochemical technique in which antibodies are chemically conjugated to fluorescent dyes for instance FITC which are then bound directly or indirectly to the target antigen [33].

Serum proteins constitutes adhesion factors that play a major role in integrin mediated cell adhesion, following experiment was designed to quantify adhesion of VTN and FN to electrospun polymer blend of PDL and PAA compared with glass.

Electrospun mats were fabricated onto sterilize coverslips half of the samples were submerged in 10% Fetal bovine serum (FBS) and rest were coated with aqueous solution of purified FN and VTN.

In order to improve predictability and minimize variables controls were added, positive controls validate proper staining procedure to make sure antibody binds correct antigen. Primary antibodies were mixed with purified proteins resulting in loss of functionality prior to incubation, latter samples were washed to remove excess antibodies followed by labelling them with secondary antibodies.

To ascertain the specificity of the staining procedure negative controls are applied which help in identifying false background sample preparation was kept same as positive, 10% FBS was used in place of proteins. Casein will be used to block any sort of nonspecific binding that could possibly arise as result of cross-reaction with secondary antibodies.

Target molecules of interest will be quantified in terms of binding extent, which will be represented in the form of standard curve plotted against absorbance and concentration. Positive slope of the curve demonstrate a higher measured response related to increase in amount of detection antibody.

3.2.1 Antibodies

Polyclonal rabbit anti-fibronectin was bought from (Sigma Aldrich), polyclonal donkey anti-rabbit IgG antibody used for indirect measurement of fibronectin was purchased from (Life technologies). Monoclonal mouse anti-bovine vitronectin and donkey anti-mouse IgG antibody was purchased from life technologies.

3.2.2 Surface Coating

Glass coverslips (18x18 mm²) were etched with 70% ethanol and dried, four different concentrations of each VTN and FN were tested whereas rest of the specimen were coated with 10% FBS as shown below (table 3)

Table 3: Immunoassay specimen trials

| | |
|----------|-----------------------|
| SAMPLE 1 | VTN 5% - FN 1% |
| SAMPLE 2 | VTN 10% -FN 2% |
| SAMPLE 3 | VTN 15% - FN 3% |
| SAMPLE 4 | VTN 20% - FN 5% |
| SAMPLE 5 | VTN 0%-FN 0%-FBS 10% |
| SAMPLE 6 | VTN 0%- FN0%- FBS 10% |
| SAMPLE 7 | VTN 0%- FN 0%- FBS10% |

Per coverslip, 200 μ L of 5%, 10%, 15%, 20% VTN solution concentration (in PBS solvent) and PBS solvent of 1%, 2%, 3%, 5% FN was deposited. After deposition incubate for 1 hour at room temperature or 37°C with casein buffer to block nonspecific binding.

In the next step samples were incubated with primary and secondary antibodies for 30 minutes and then rinsed with 1XPBS twice. Finally we visualized using scanning confocal microscope (Leica TCS SP2) for Qdot585 and Qdot525 using DAPI, FITC, Alexa633 filter set (excitation 405nm and emission 525nm,585nm).

3.2.3 Quantum Dots

Inorganic nanocrystals of semiconductor material (CdSe) with an average size of approximately 15- 20nm and diameter 1-6nm coated with a polymer shell allowing it to be conjugated with biological molecules.

Unlike organic dyes that have limited photo-stability of many near-infrared (NIR) wavelength quantum dots (Qdots) are relatively stable and offer high fluorescence quantum yield and larger molar absorption coefficient [33].

CHAPTER 4:

DISCUSSION AND CONCLUSION

4.1 Results

The project was aimed to quantify adsorption of “serum adhesion factor”, VTN and FN onto glass and electrospun fibers of poly (D-Lysine) /Poly (acrylic acid) blend.

PDL is a cationic polymer which can potentially be used for biomedical applications, we hypothesized that protein adsorption can mediate cellular interaction with glass and nanofibers through focal adhesions.

Several samples of electrospun fibers were tested against different protein concentrations but the results turned out to be inconclusive, we expected to produce quantitative and qualitative analysis by comparing and studying the intensities of fluorescence, in order to determine the loss and gain of VTN and FN.

However, we have reasons to believe that the experiment might have worked and protein could have possibly been absorbed, due to the specific pattern observed on the images below (figure 6) resembling close to shape and size of Qdots, another reason that could validate our hypothesis are the results articulated from the cell culture experiment.

Although we cannot testify our findings due to lack of signals, there are several possibilities that could account for loss of signals or staining, like every other laboratory technique immunofluorescence has certain limitations that require troubleshooting in order to get desired results some of these issues include

Non-compatible antibodies; either primary or secondary antibody was raised against the species intended, not enough primary antibody to bind with, photo-bleaching certain fluorescent dyes are sensitive to light and can easily denature.

Nonspecific binding, this is one of the most common problem which arises due to lack of proper blocking agent or high antibody concentration. Lack of sufficient incubation time period, denaturing of proteins, inappropriate dilution rates, no proper blocking of Fc receptors, aggregation of flurochrome, surface properties of specimens.

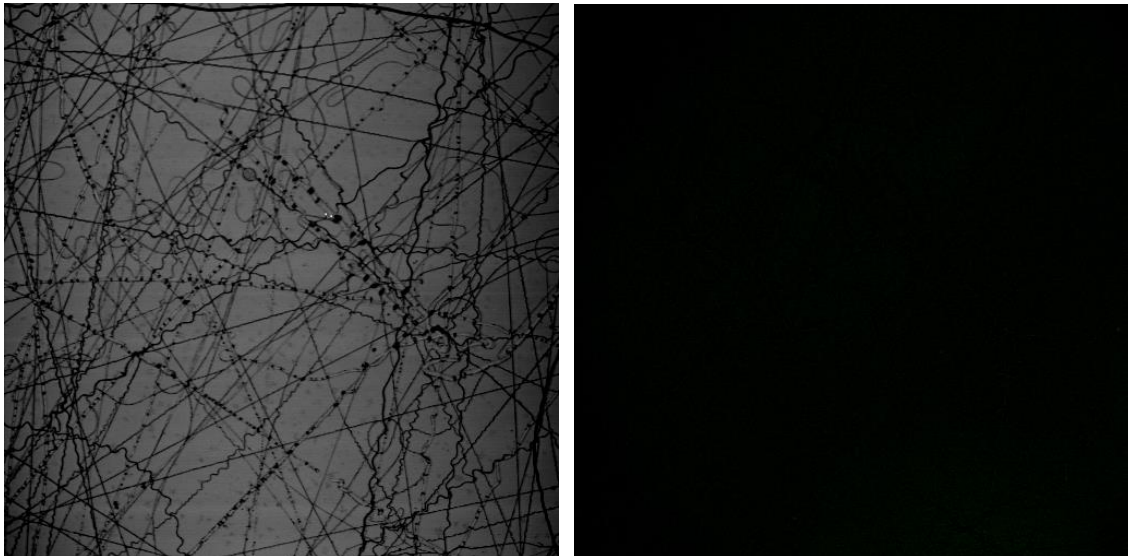

Figure 6a. VTN 5% - FN 1%

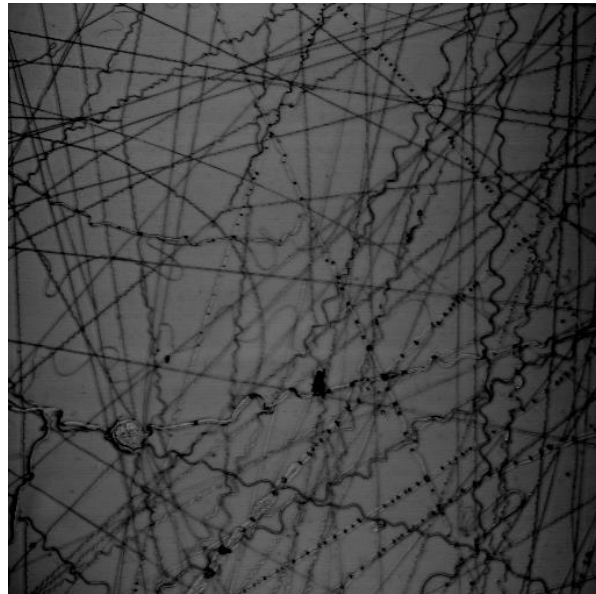
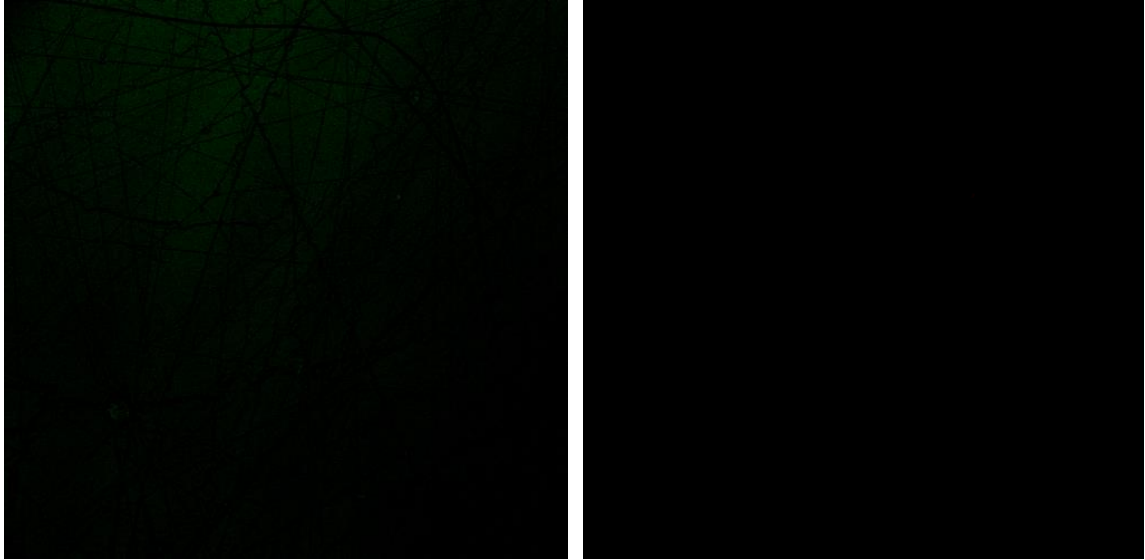

Figure 6b. VTN 10% - FN 2%

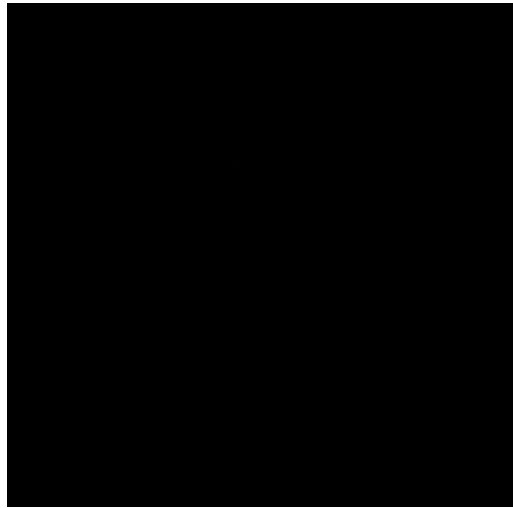
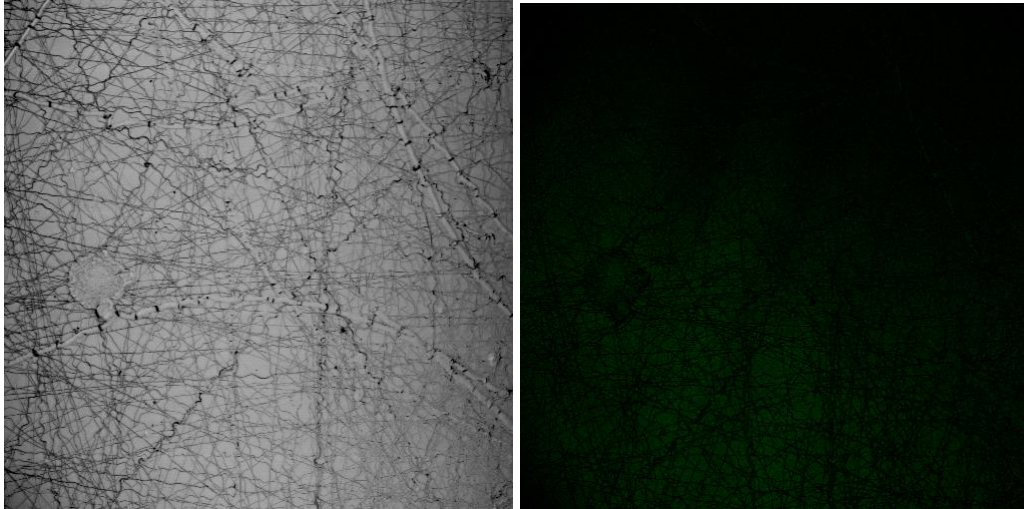

Figure 6c. VTN 15% - FN 3%

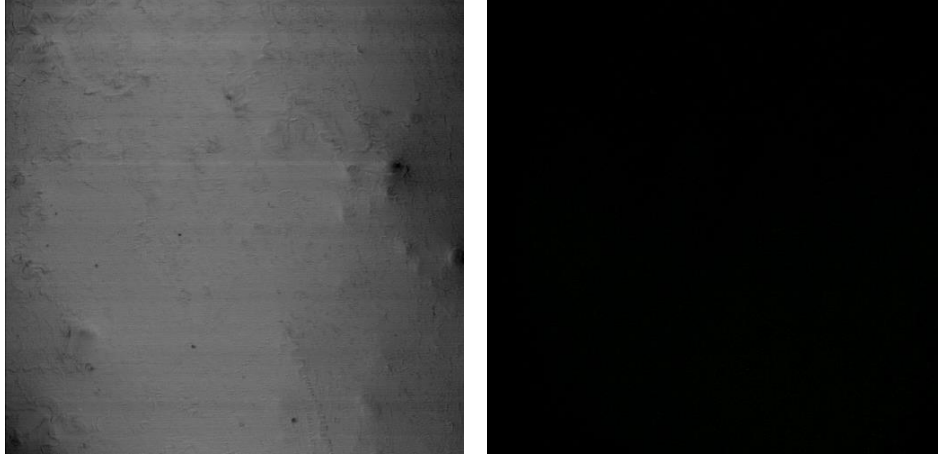

Figure 6d. VTN 20% - FN 5%

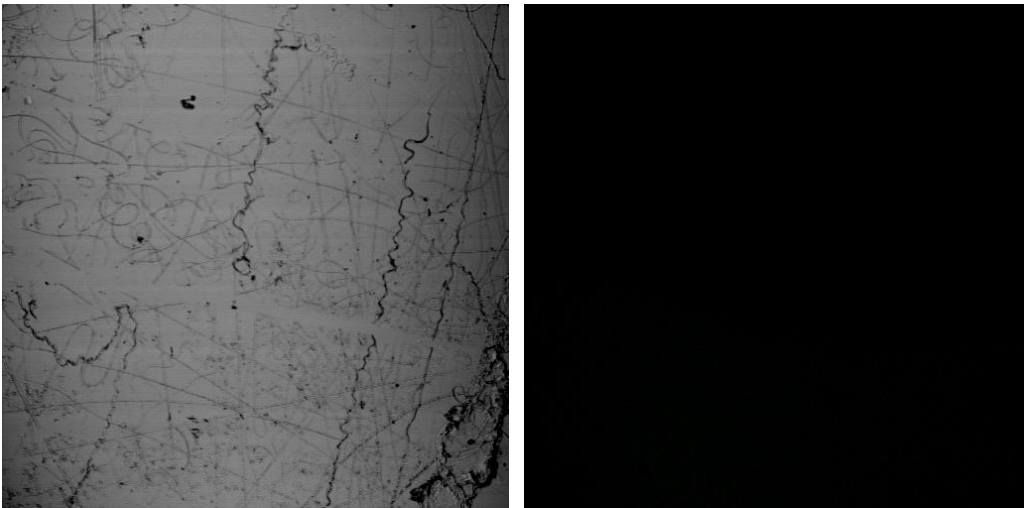

Figure 6e. 10% FBS

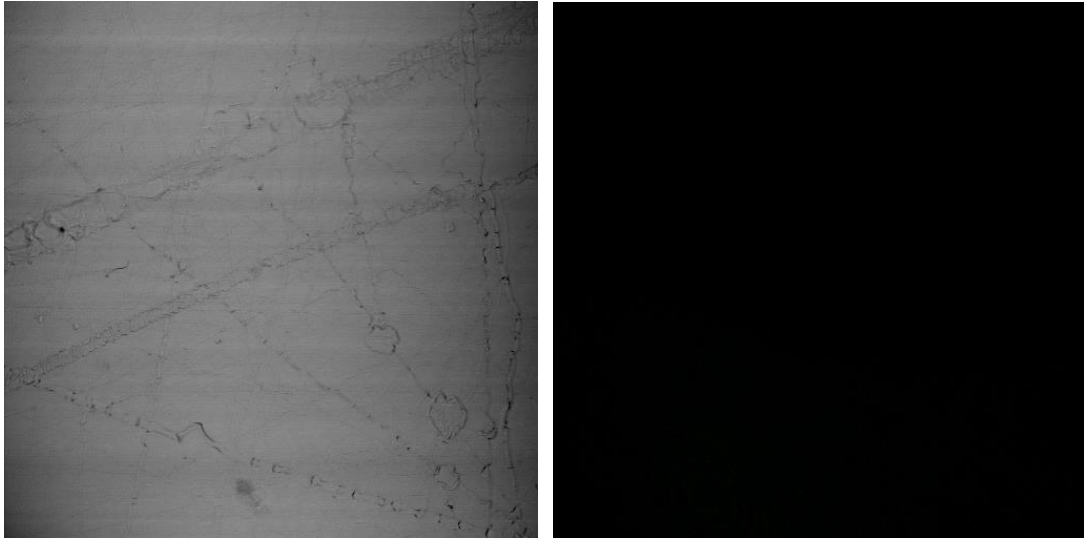

Figure 6f. 10% FBS

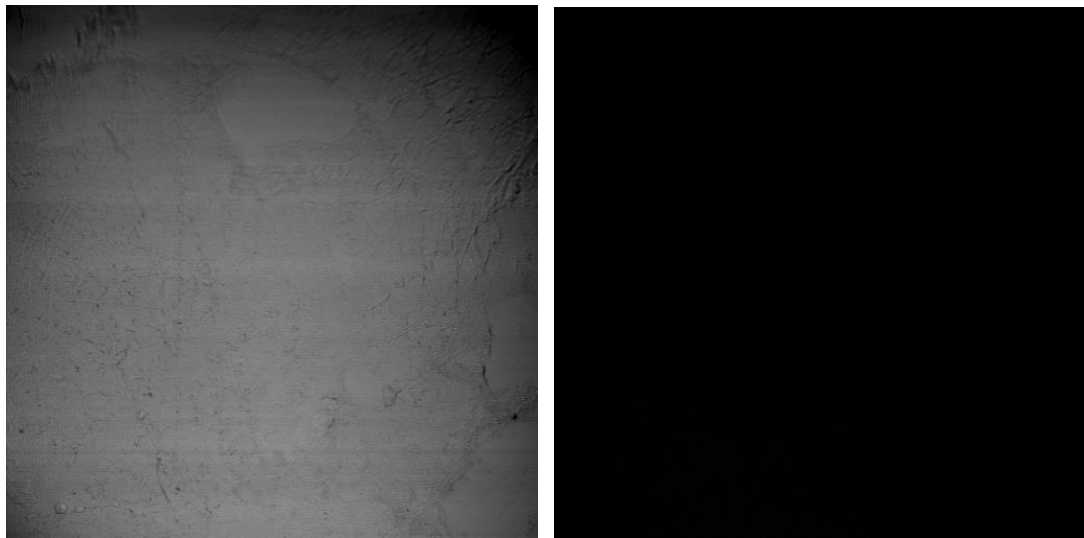

Figure 6g. 10% FBS

REFERENCES

- [1] Niall Finn, Clemence Carlinet, George Maurdev. "Electrospun poly (acrylic acid) / Lysine fibers and the interactive effects of moisture, heat and cross-link density on their Behavior", *J.Appl.Polym.Sci.*2015, 132, 41252.
- [2] Jessica D. Schiffman, Caroline L. Schauer. A Review: "Electrospinning of biopolymer nanofibers and their application", *Polymer Reviews*.2008, 317-352.
- [3] Boris Michael Holzapfel, Johannes Christian Reichert, Jan-Thorstern Schantz, Uwe Gbureck, Lars Rackwitz, Ulrich Noth, Franz Jakob, Maximilian Rudert, Jurgen Groll, Dietmar Werner Hutmacher. "How smart do biomaterials need to be? A translational science and clinical point of view", *Adv. Durg Deliv. Rev.* 65 (2013), 581-603.
- [4] Oladeji O.Ige, Lasisi E. Umoru, Sunday Aribu. Natural Products: "A minefield of biomaterials", *ISRN Materials Science*. 2012(2012), 20.
- [5] R.A Thakur, C.A.Florek, J.Kohn, B.B Michniak. "Electrospun nanofibrous polymeric scaffold with targeted drug release profiles for potential application as wound dressing". *International Journal of Pharmaceutics* 364 (2008) 87-93.
- [6] Dhan B. Khadka, MS, Donald T.Haynie, PhD. "Protein and peptide-based electrospun nanofibers in medical biomaterials". *Nanomedicine: NBM* 2012; 8:1242-1262.
- [7] D. Seiffert. "Constitutive and regulated expression of vitronectin". *Histol Histopathol* (1997) 12:787-797.
- [8] Iris Schvartz, Dalia Seger, Shmuel Shaltiel. "Vitronectin". *The International Journal of Biochemistry and Cell Biology*, 31 (1999) 539-544
- [9] Jing Zeng, Xiaoyi Xu, Xuesi Chen, Qizhi Liang, Xinchao Bian, Lixin Yang, Xiabin Jing. "Biodegradable electrospun fibers for drug delivery". *Journal of Controlled Release* 92, (2003)227-231.
- [10] Shirley Wong, Min Suk Shim, Young Jik Kwon. "Synthetically designed peptide-based biomaterials with stimuli responsive and membrane- active properties for biomedical applications". *J. Mater. Chem. B*, 2 (2014), 595.

- [11] Mengyan Li, Mark J Mondrinos, Milind R. Gandhi, Frank K. Ko, Anthony S. Weiss, Peter I. Lelkes. "Electrospun protein fibers as matrices for tissue engineering". *Biomaterials*, 26 (2005) 5999-6008.
- [12] Tal Dvir, Brian P. Timko, Daniel S. Kohane, Robert Langer. "Polymeric biomaterials in tissue engineering". *Pediatr Res*, 63 (2008), 487-491.
- [13] Magnus K. Magnusson, Deane F. Mosher. "Fibronectin structure, assembly and cardiovascular implications". *Arterioscler Thromb Vasc Biol.* 18 (1998): 1363-1370.
- [14] Richard A. Proctor, "Fibronectin: A brief overview of its structure, function and physiology". *Review of Infectious Diseases.* 9 (1987): S317-S321.
- [15] Yong Mao, Jean E. Schwarzbauer. "Fibronectin fibrillogenesis, a cell-mediated matrix assembly process". *Matrix Biology*, 24 (2005), 389-399.
- [16] Edward G. Hayman, Erkki Ruoslahti. "Distribution of fetal bovine serum fibronectin and endogenous rat cell fibronectin in extracellular matrix". *J. Cell Biology.* 83 (1979), 255-259.
- [17] Klaus T. Preissner. "Structure and biological role of vitronectin". *Annu. Rev. Cell Biol.* 7 (1991): 275-310.
- [18] Marsha D. Bale, Lisa A. Wohlfahrt, Deane F. Mosher, Bianca Tomasini, Richard C. Sutton. "Identification of vitronectin as a major plasma protein adsorbed on polymer surfaces of different copolymer composition". *Blood, Vol 74* (1989): 2698-2706.
- [19] Igor Buchwalow, Vera Samoilova, Werner Boecker, Markus Tiemann. "Nonspecific binding of antibodies in immunohistochemistry: fallacies and facts". *Scientific Report* 1, 28 (2011): 1-6
- [20] Katsuro Shinoda, Toshio Hayashi, Toru Yoshida, Kazuhiko Sakai, Akio Nakajima. "Complex formation of poly-L-lysine with poly (acrylic acid)". *Polymer Journal*, 8 (1976): 202-207.
- [21] Todd C. Holmes, "Novel peptides-based biomaterials scaffolds for tissue engineering". *Trends in Biotechnology*, 20 (2002): 16-21.
- [22] Raymund Machovich, Peter Aranyi "Effects of heparin on thrombin inactivation by antithrombin- III". *Biochem. J.* 173(1978), 869-875.

- [23] Jurg Tschopp, Daniele Masson, Sylvie Schafer, Manuel Peitsch, Klaus T. Preissner. "The heparin binding domain of s-protein/vitronectin binds to complement components C7, C8 and C9 and perforin from cytolytic T-Cells and inhibits their lytic activities". *Biochemistry*. 27(1988): 4103-4109.
- [24] Christian Frantz, Kathleen M. Stewart, Valerie M. Weaver. "The extracellular matrix at a glance". *Journal of Cell Science*. 123 (2010): 4195- 4200.
- [25] Staffan Johansson, Gunbjorg Svineng, Krister Wennerberg, Annika Armulik, Laris Lohikangas. "Fibronectin–integrin interactions". *Frontiers in bioscience*. 2(1997): 126-146.
- [26] Richard W. Burry. "Controls for immunocytochemistry: an update". *Journal of Histochemistry and Cytochemistry*. 59 (1) 6-12, 2011.
- [27] Li Yan Qiu, You Han Bae. "Polymer architecture and drug delivery". *Pharmaceutical Research*, Vol.23, No.1, 2006: 1-30.
- [28] Dhan B. Khadka, Michael C. Cross, Donald T. Haynie. "A synthetic polypeptide electrospun biomaterial". *ACS Appl. Mater. Interfaces*. 2011, 3(8): 2994-3001.
- [29] <https://www.thermofisher.com/antibody/product/Donkey-anti-Mouse-IgG-H-L-Secondary-Antibody-Polyclonal/Q22079>
- [30] <http://www.abcam.com/protocols/troubleshooting-and-using-controls-in-ihc-and-icc>
- [31] <http://www.leica-microsystems.com/science-lab/how-to-prepare-your-specimen-for-immunofluorescence-microscopy/>
- [32] <https://www.thermofisher.com/us/en/home/brands/molecular-probes/key-molecular-probes-products/qdot/frequently-asked-questions.html>
- [33] http://www.dako.com/08002_03aug09_ihc_guidebook_5th_edition_chapter_10.pdf
- [34] Wayne R Gombotz, Wang Guanghui, Thomas A Horbett, Allan S. Hoffman. "Protein adsorption to poly (ethylene oxide) surfaces". *Journal of Biomedical Materials Research*, Vol 25, Issue 12, 1991, 1547-1562.

APPENDIX A: COPYRIGHT PERMISSIONS

Below is permission for Table 2.

ISRN Materials Science

Volume 2012 (2012), Article ID 983062, 20 pages

<http://dx.doi.org/10.5402/2012/983062>

Review Article

Natural Products: A Minefield of Biomaterials

Oladeji O. Ige,¹ Lasisi E. Umoru,¹ and Sunday Aribó²

¹Department of Materials Science and Engineering, Obafemi Awolowo University, Ile-Ife 220282, Nigeria

²Department of Metallurgical and Materials Engineering, Federal University of Technology, Akure 340252, Nigeria

Received 16 November 2011; Accepted 5 January 2012

Academic Editor: E. Burkel

Copyright © 2012 Oladeji O. Ige et al. This is an open access article distributed under the [Creative Commons Attribution License](#), which permits unrestricted use, distribution, and reproduction in any medium, provided the original work is properly cited.

 Abstract

 Full-Text PDF

 Full-Text HTML

 Full-Text ePUB

 Full-Text XML

 Linked References

 Citations to this Article

 How to Cite this Article